



Center for Hydrology
H y d r o l o g i c a l O b s e r v a t o r y

Nye hydrogeofysiske målemetoder

Majken Looms

mcl@geo.ku.dk



Voulund, HOBES landbrugslokalitet

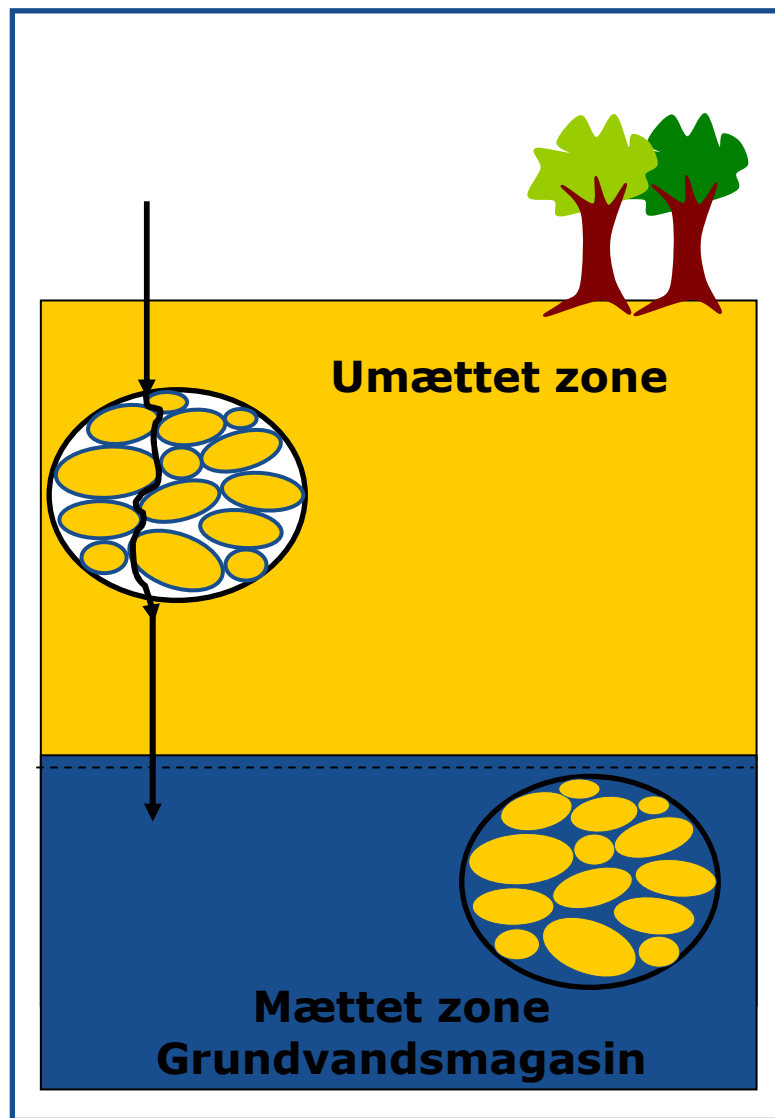

- Ønsker:
 - In situ
 - For et forholdsvis stort areal
 - Uden at forstyrre den naturlige geologi
- Metoder:
 - TDR-prober
 - Lysimetre
 - Massebalance betragtninger (= Nedbør – Fordampning)
 - Etc.

- Nye hydrogeofysiske målemetoder

- **Cross-borehole georadar**
- **Cross-borehole geoelektrik**



5 m

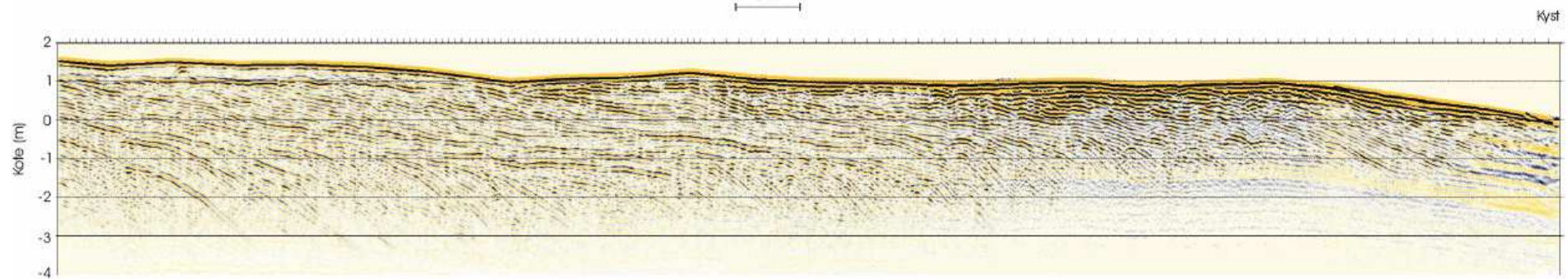

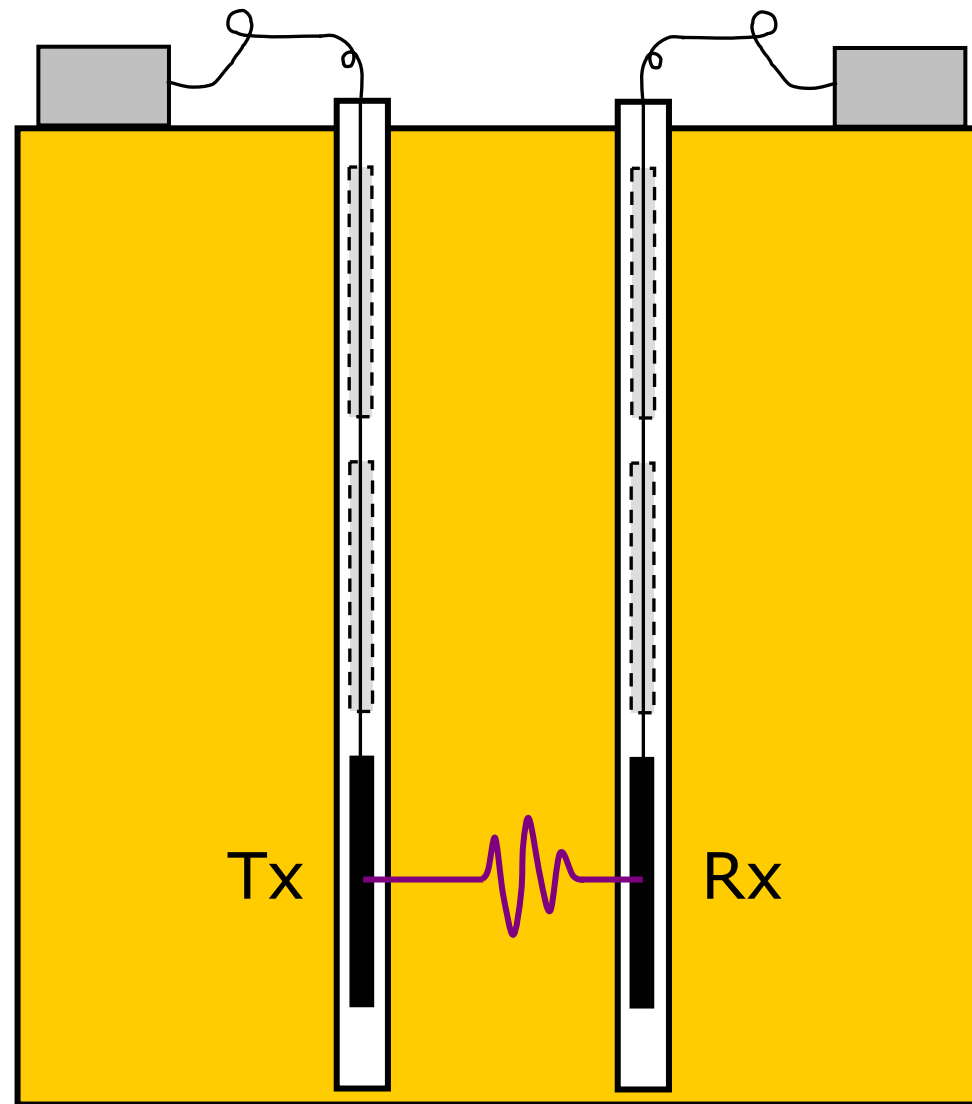

Måler vandindholdet

Cross-borehole georadar

7

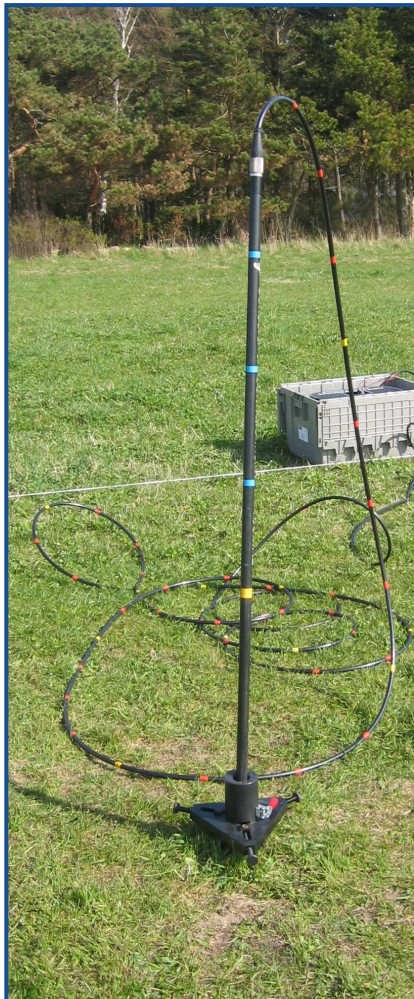

Multielektrodeprofilering (MEP)

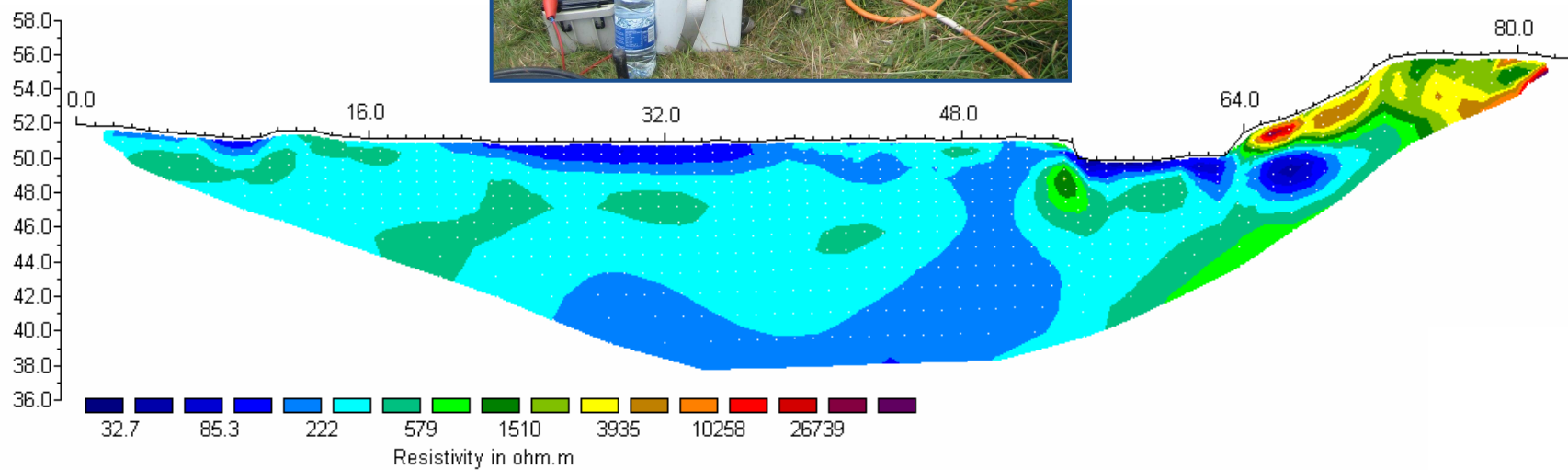
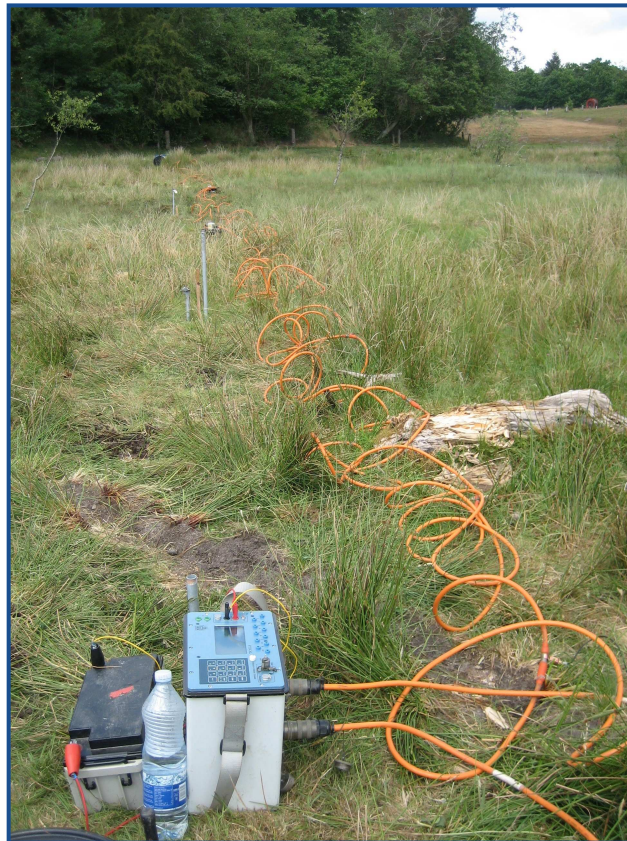

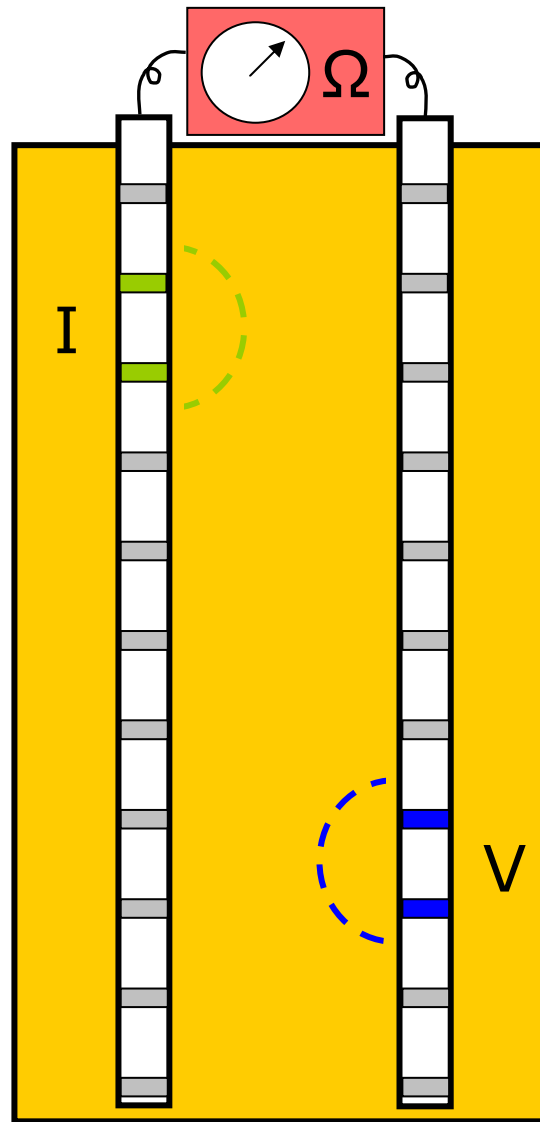

Måler modstanden

Cross-borehole geoelektrik

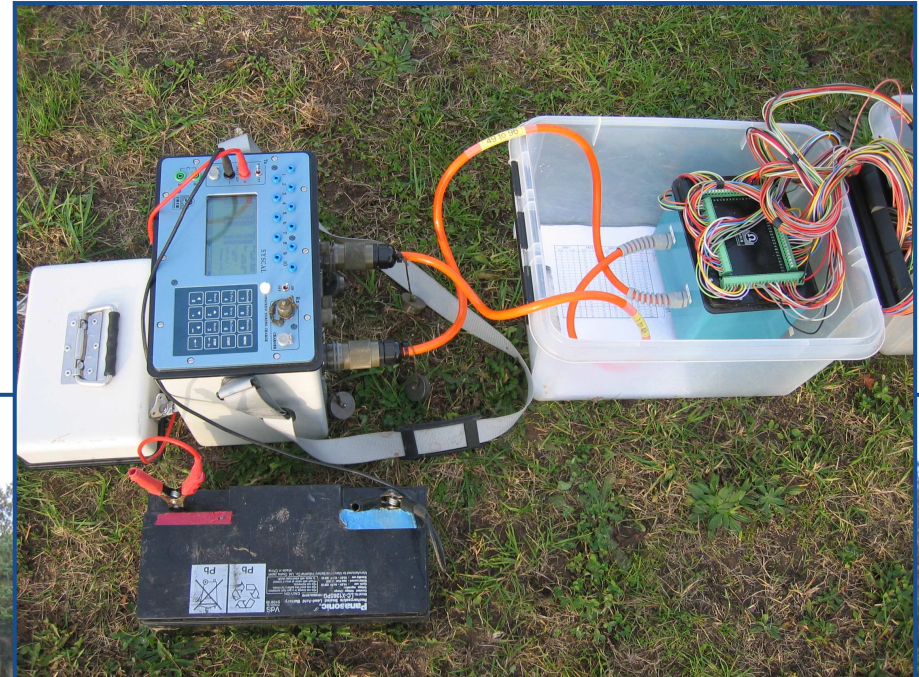
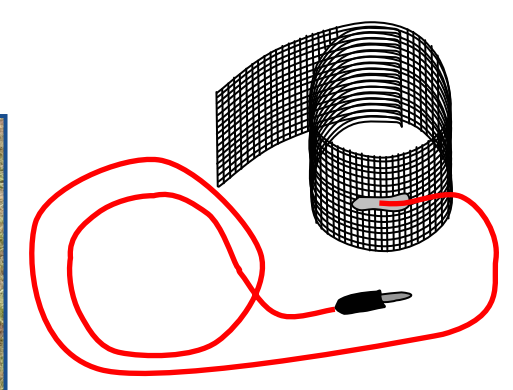
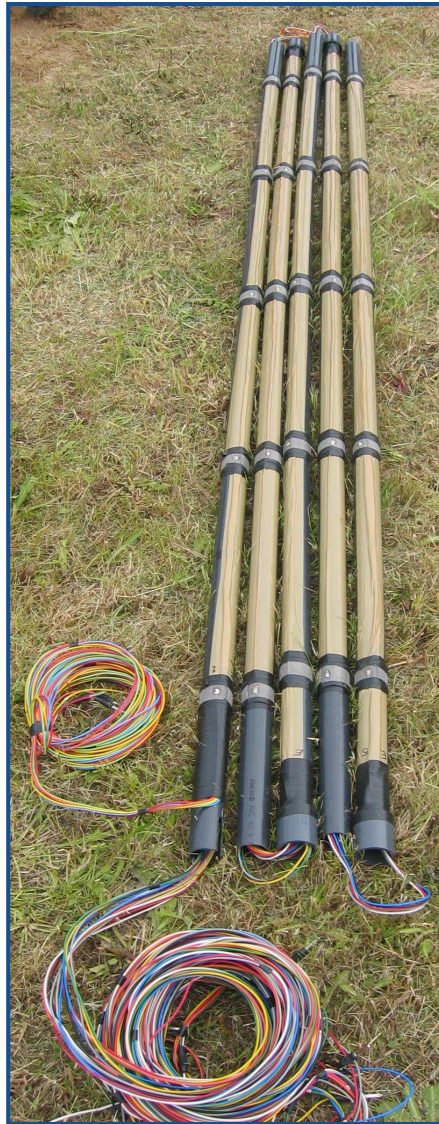

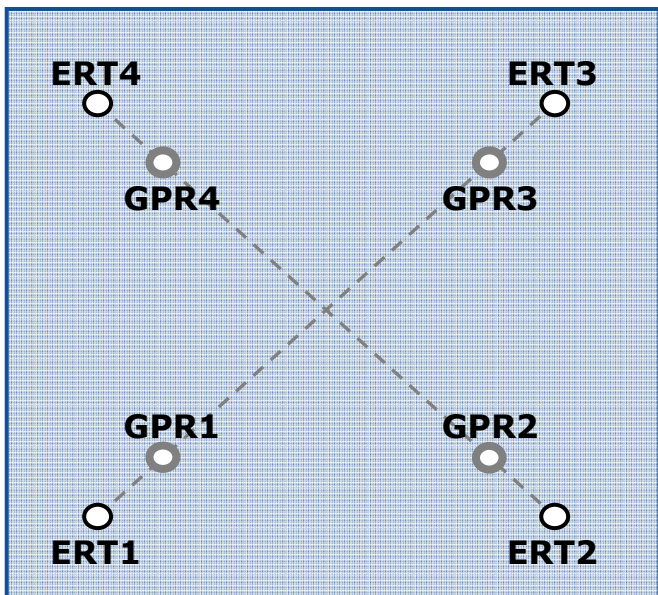
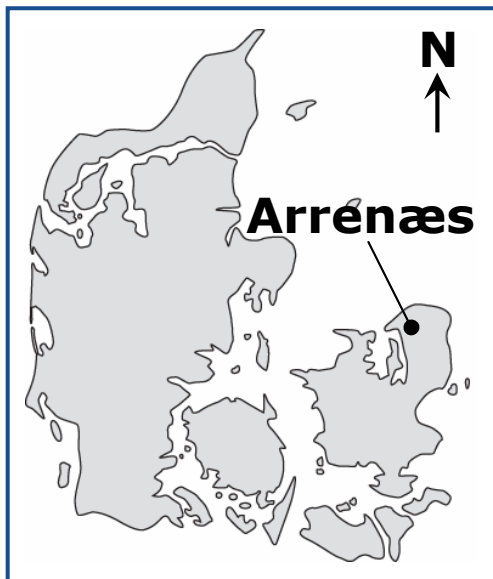

○ ERT Boreholes
● GPR Boreholes

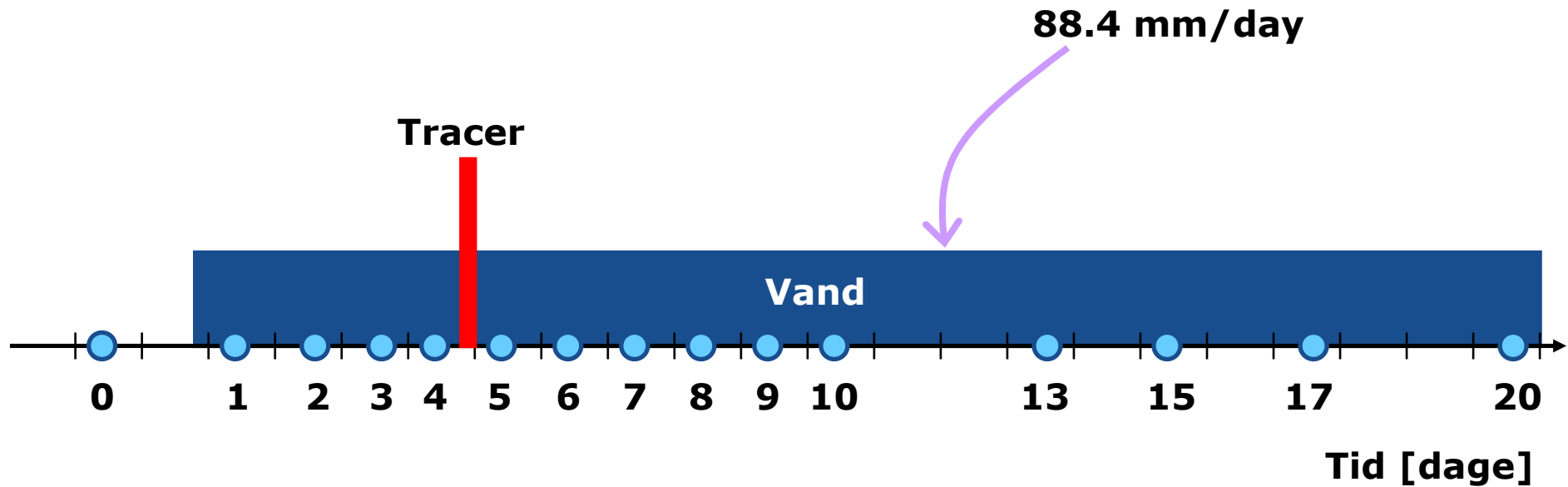

● Data indsamling

Cross-borehole georadar

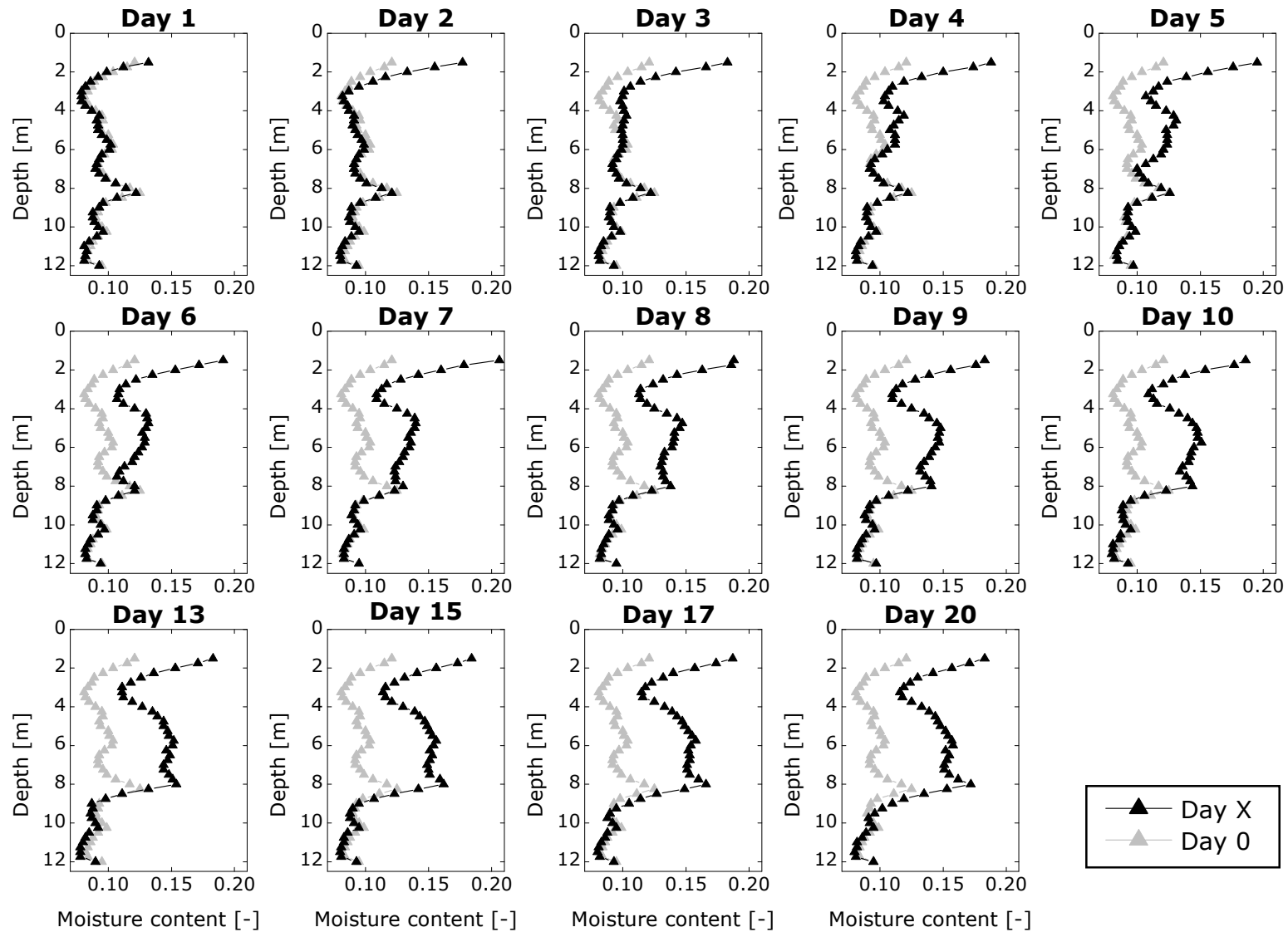

Cross-borehole geoelektrik

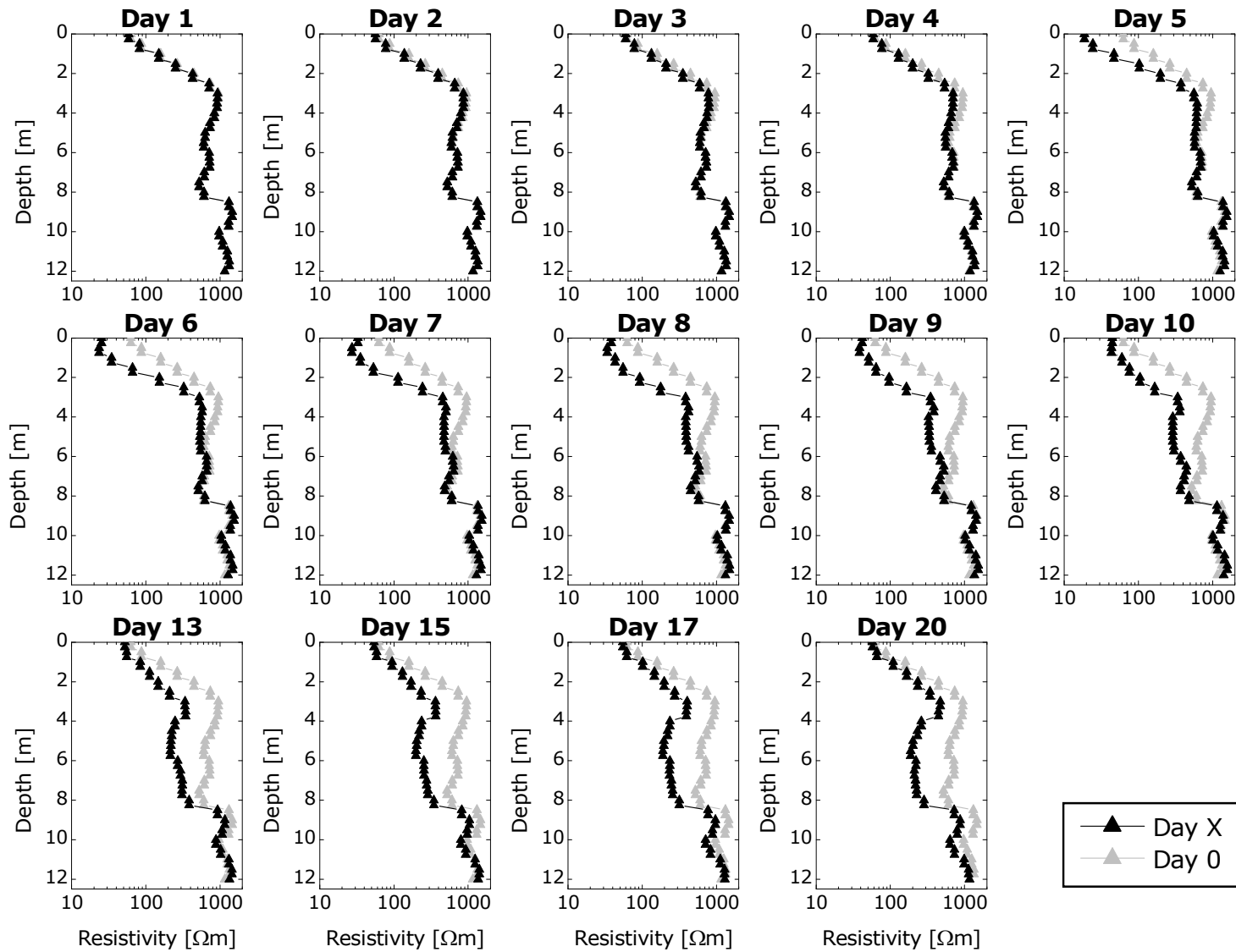

Georadar + Geoelektrik =
Vandindhold Resistivitet

Porevandsledningsevne (tracer koncentration)

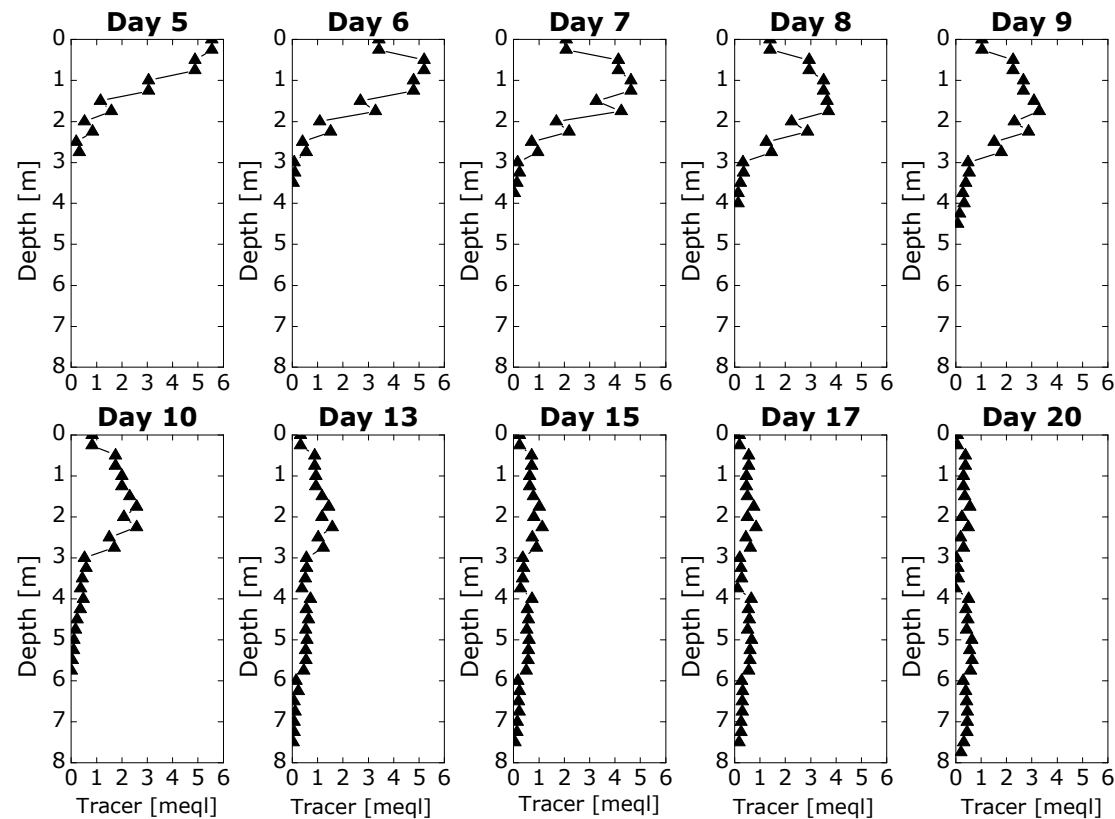

- **Hydrogeofysiske målemetoder**
 - **Konsistente data for vandindhold og modstanden**
 - **Kombineret analyse kan bruges til at bestemme porevandshastigheden, og dermed nedsivningen**
 - **Resultere i 2D og 3D data → mål for variation**
- **Ulemper**
 - **Kræver specielt udstyr og specielt installerede borehuller**